

XIZI GROUP creates **infinite possibilities**  
for construction traffic

---

XIZI Elevator Co., Ltd

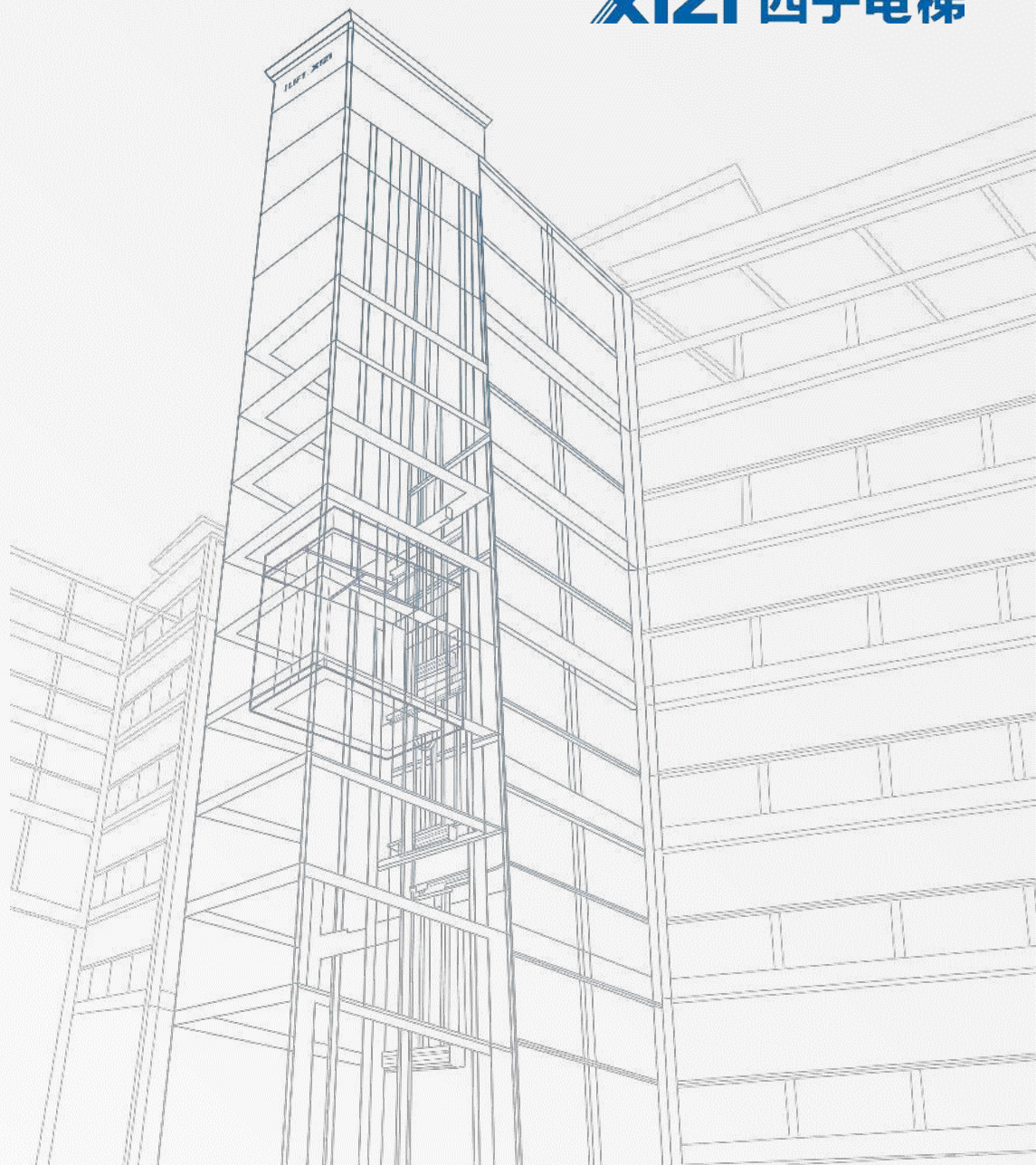

# CONTENT

**A** Company Profile

**B** Innovative R&D

**C** Manufacturing

**D** Marketing Network

**E** Engineering Guidance

**F** Products Introduction

**G** Classical Projects

A

Company Profile

---

汇聚梦想 分享成长

Headquarters- **XIC**

## XIC - TOP 500 ENTERPRISES IN CHINA

【 A large enterprises group spans across multiple industries,  
with manufacturing as the core □

**10000+**

Total employee

**376 billion**

Business income in 2024

# XIZI ELEVATOR CO.,LTD.

8 10 million

Total investment

355.5 million

Registered capital

200,000 □

Covering area

over 150,000 units

Yearly capacity

over 40,000 units

Total order  
volume in 2024



# COMPANY HISTORY

XIZI 西子电梯



1981年

XIZI Elevator Factory was established in Hangzhou



1987年

Installation license obtained



1989年

XIZI Elevator installed escalators for Hangzhou Department Store



1993年

The first elevator exported to Vietnam by XIZI



1997年

XIZI OTIS Elevator Co., Ltd. was established



2007年

Elevator components of XIZI ranked Top1 in China

2024年

XIZI Elevator Hengfan digital factory put into use



2022年

The annual orders exceeded 40,000 sets



2021年

The 40th Anniversary of XIZI Brand



2015年

Lin'an factory of XIZI has been put into operation



2013年

Sales network covers more than 60 countries and regions around the world, 34 branches and 28 offices in China



2008年

Hangzhou UNITE Elevator Co., Ltd. was established



# Certificate system



## System certification

## Product certification



ISO 9001  
quality  
management  
system



ISO 14001  
environment  
management  
system



ISO 45001  
Occupational health  
and safety  
management system



Russian certificate



Malaysia JKKP  
certificate



CE certificate

B

Innovative R&D

联合创造力  
COMBINE THE CREATIVITY

Strong R&D team

研发中心  
R & D Center

200<sup>+</sup>

R&D engineers

□ 15%

Proportion of all employees

Awarded as □ zhejiang xizi intelligent elevator research institute □

Awarded as □ zhejiang high-tech enterprise research and development center □

Awarded as □ Zhejiang Provincial Enterprise Technology Centre □

Awarded as □ Zhejiang Provincial Enterprise Technical Center □

Awarded as □ Zhejiang Provincial Industrial Design Center □

Awarded as □ Zhejiang Provincial Postdoctor Work Station □

Selected as □ 2023 Annual “ Pilot” Research & Tackle Key Problems Plan □

Test Tower

XIZI 西子电梯



## Phase 1

98 m

The height

7 m/s

Maximum speed of  
the lift in the tower

5 T

Maximum load  
capacity

## Phase 2

208 m

The height

10 m/s

Maximum speed of  
the lift in the tower

8 T

Maximum load  
capacity

# National test center



## Reliability testing of key components

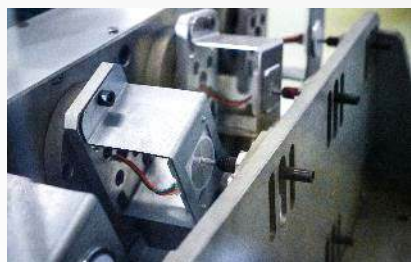

Button fatigue test



Steel wire fatigue test



Door operator switch door fatigue test



Hall door strength test



China Recognition  
International  
Mutual Recognition  
TESTING  
CNAS LXXXX

## Environmental testing of key components



Mechanical Vibration Test



Water-proof test



Dust test



High and low temperature test

# Patents

113

Technology patents

5

Patents for inventions

# Participating standard

3 set

65 sets

Chaired Edition of Elevator Industry National/Group Standard

Participated Edition of Elevator Industry National/Group Standard



## 中华人民共和国国家标准

GB/T24808-2009

GB/T 26469—2021

设置在前厅或轿厢内的供水... 5.3.2 设置在轿厢... 5.3.3 设置在轿厢... 5.3.4 设置在轿厢... 5.4 消防报警系统

GB/T 26469—20

11.1 为了保... 11.2 维修的... 11.3 定期检修... 11.4 紧急呼... 11.5 报警系... 11.6 报警系... 11.7 报警系... 11.8 报警系... 11.9 报警系... 11.10 报警系...

1 范围

- 1.1 本文件... 1.2 本文件... 1.3 本文件... 1.4 本文件... 1.5 本文件...

GB/T 26469—2021

GB/T 26469—2021

保证人民安全... 11.1 为了保... 11.2 维修的... 11.3 定期检修... 11.4 紧急呼... 11.5 报警系... 11.6 报警系... 11.7 报警系... 11.8 报警系... 11.9 报警系... 11.10 报警系...

GB/T 26469—2021

序号
1
2
3
4
5
6
7
8
9
10
11
12
13
14
15
16
17
18
19
20
21
22
23
24
25
26
27
28
29
30
31
32
33
34
35
36
37
38
39
40
41
42
43
44
45
46
47
48
49
50
51
52
53
54
55
56
57
58
59
60
61
62
63
64
65

GB/T 26469—2021

GB/T 26469—2021

# Core technologies

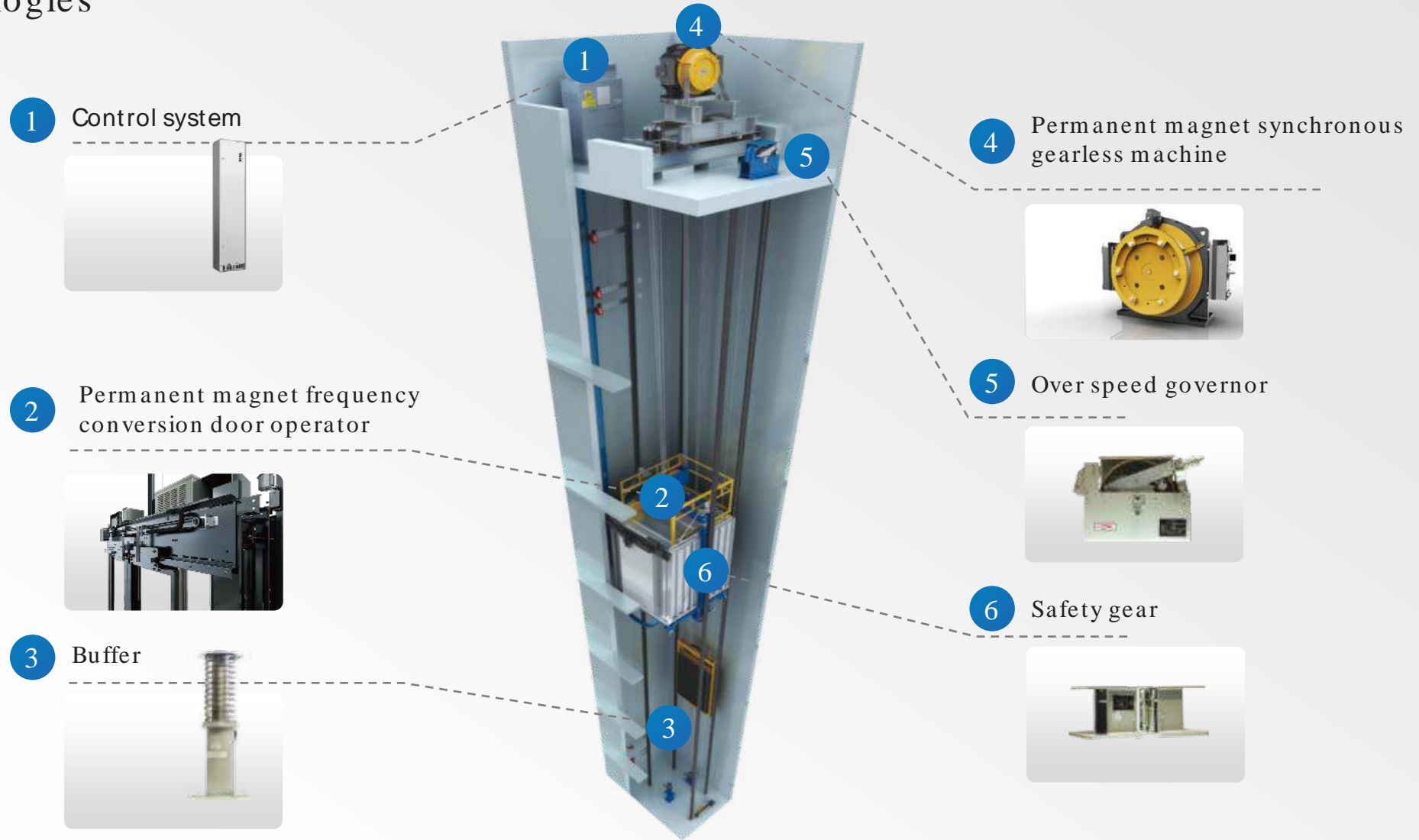

## Machine Room-less Technology (MRL)

The ultra-thin disc motor design is adopted to improve the utilization rate of the shaft, save the construction cost, and achieve the most perfect solution for the building.



### More compact

- Ultra-thin motor
- Small size and compact structure
- Save building space

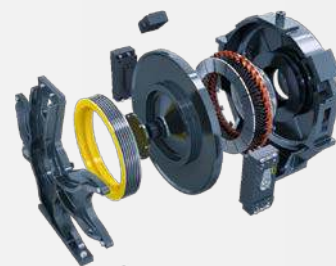

### More environmentally friendly

- Use parallel magnetic field structure
- Sealed Bearings
- No need to change grease, no pollution



### More stable

- High temperature resistant magnetic steel
- Permanent magnetic
- Improve the stability



### More quiet

- Adopt silent brake
- Control cabinet mute technology
- Improve the elevator experience

## Core technologies

XIZI 西子电梯

### Belt technology

The traction medium adopts the original imported composite steel belt instead of the steel wire rope, which allows passengers to enjoy a comfortable experience.

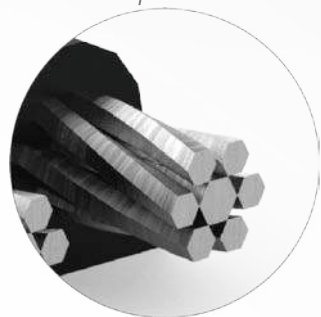

#### Safer

The safety performance is much higher than that of steel wire rope  
Each can withstand 40 KN tensile force  
After more than a dozen safety tests



#### More durable

Simple bending more than 12 million times  
Super long service life  
It is more than 10 times that of steel wire rope



#### More comfortable

The rope diameter ratio is bigger than 40  
Better than steel wire rope elevators  
Reduce vibration and optimize elevator experience

# Escalator core technology

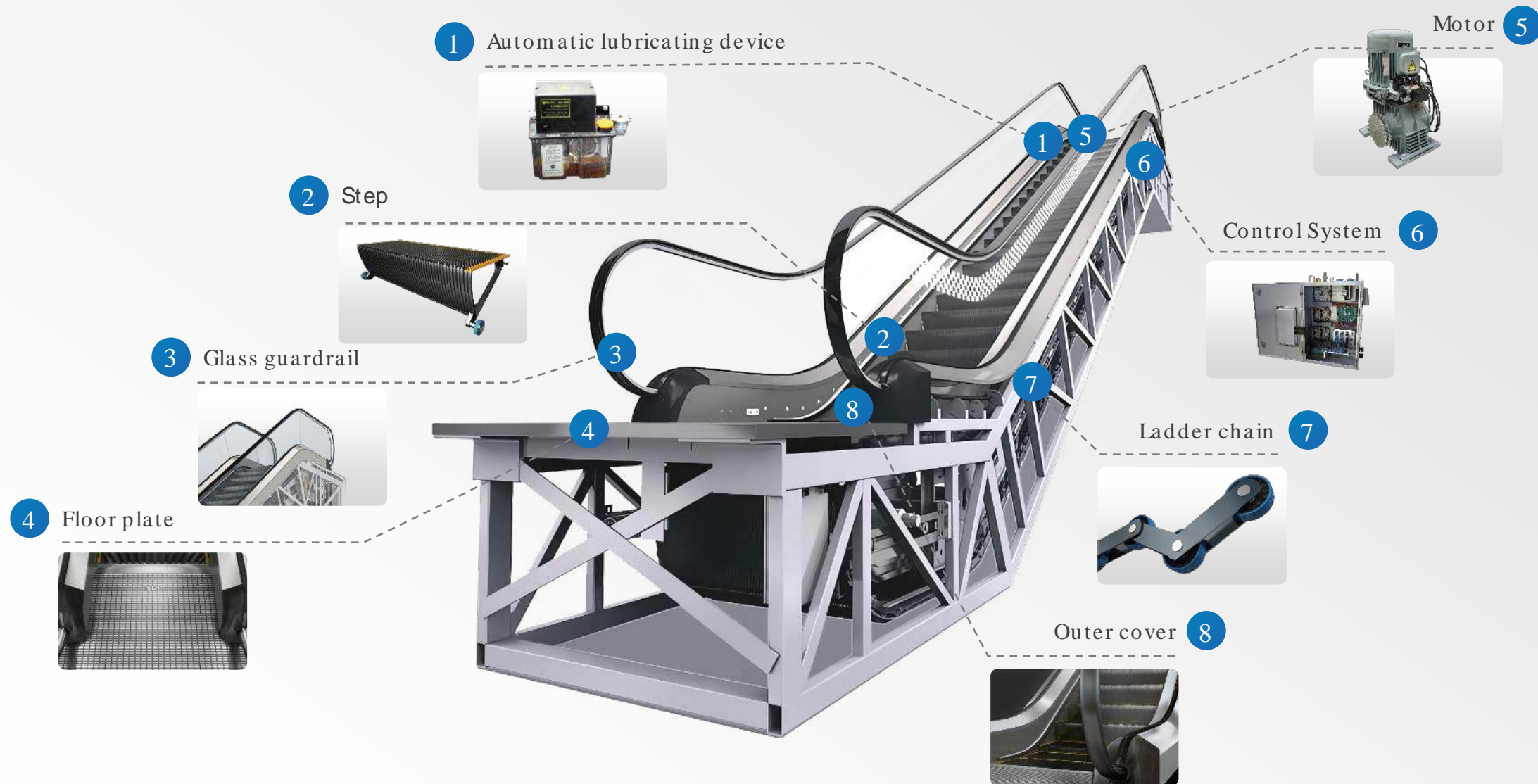

## Integrated drive technology

The integrated drive main engine is adopted, which innovates the chain transmission and eliminates safety hazards such as loose chains.



### Safer

Prevent the main drive chain from loosening  
Risks such as host displacement  
Safer to drive



### Easy maintenance

High accuracy for position detection  
Transmission is more efficient  
Simple post-maintenance

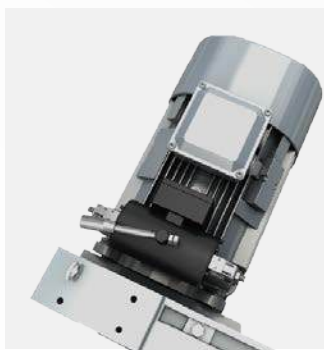

### More comfortable

Low noise brake  
Reduce operating vibration  
More comfortable experience



### More environmentally friendly

Lower civil engineering requirements  
Reduce oil pollution  
More environmentally friendly

C

Manufacturing

---

# Intelligent Factory



Production line automation

Smart Storage

Smart Logistics

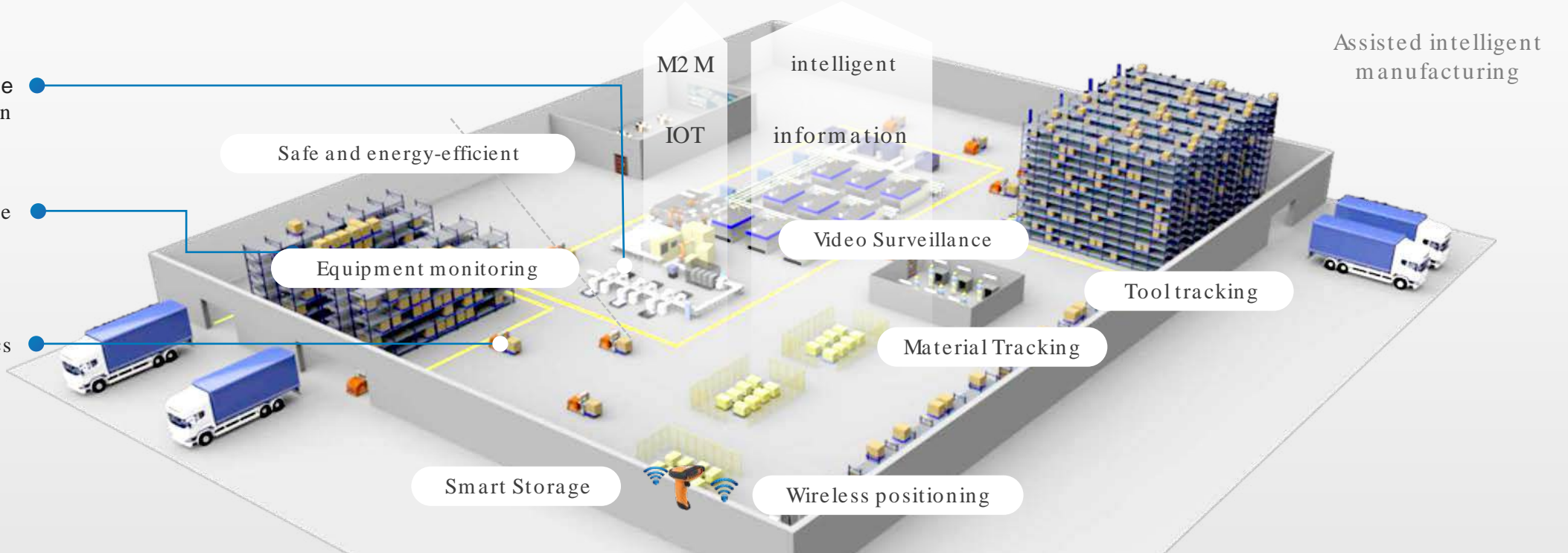

Command Center visualization



Real-time equipment management



Automation of process control



Intelligent inventory management



Digital logistics management



Closed-loop abnormal management



Intelligent quality management

# Hengfan Digital Factory

Located in Hengfan Industrial zone of LinAn district of Hangzhou, Hengfan factory focuses on manufacturing and R & D of core components of elevator. It owns professional elevator cable test center, door operator manufacturing line, painting line, SMT and automatic display production line, equipped with NTC, digital bending and cutting machines, etc.





Robot Automatic Welding  
Line for Top and Bottom Car



Automatic Punching Processing  
Line for Elevator Parts



Automatic Laser Loading &  
Unloading Production Line



Automatic Production  
Line for Cabin

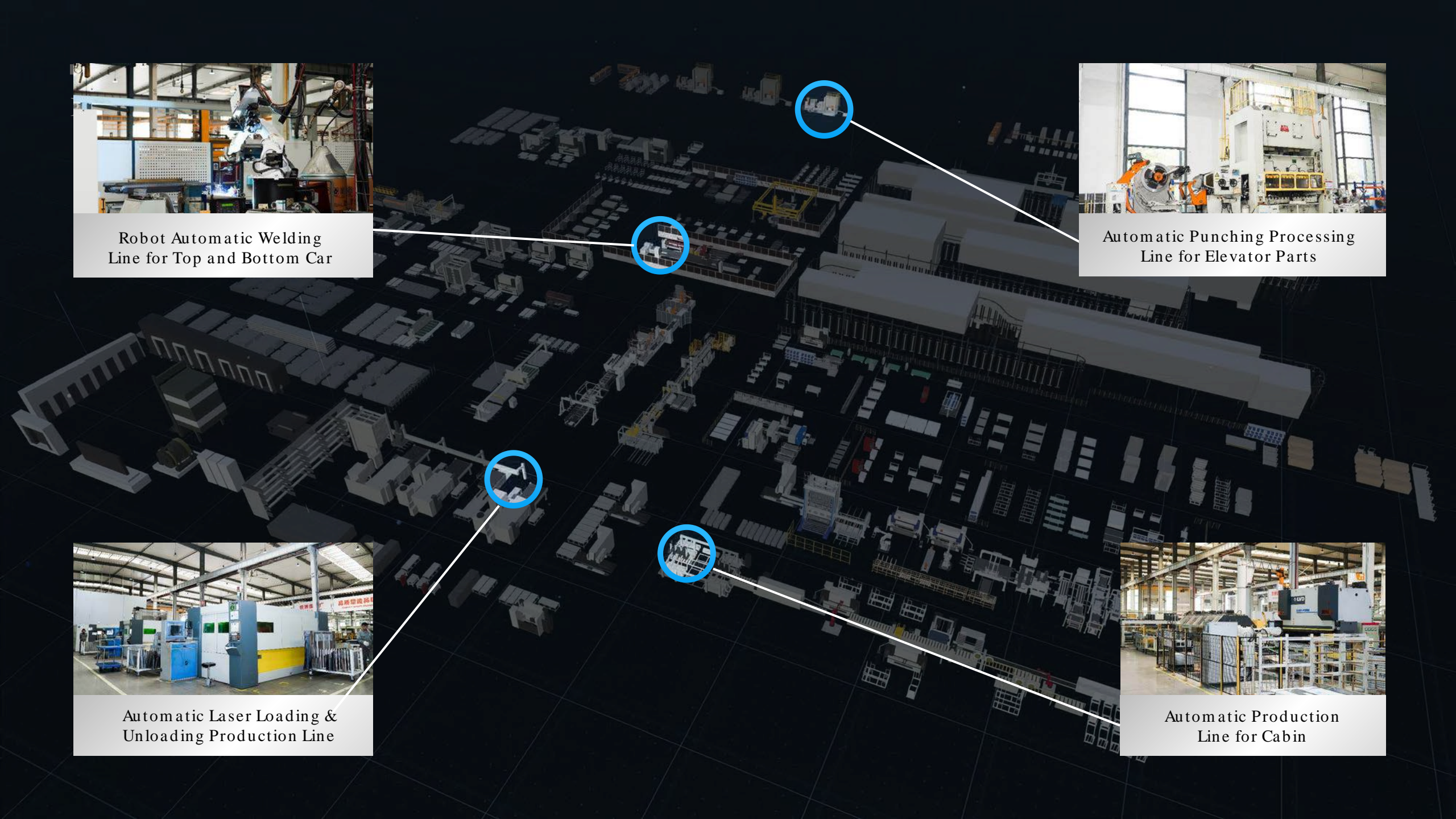



Automatic Landing Door  
Production Line



Door Panel Automatic  
Powder Supplement Line



Automatic Painting Landing  
Door Production Line



Stainless Steel Landing Door  
Production Line



---

# Intelligent manufacturing

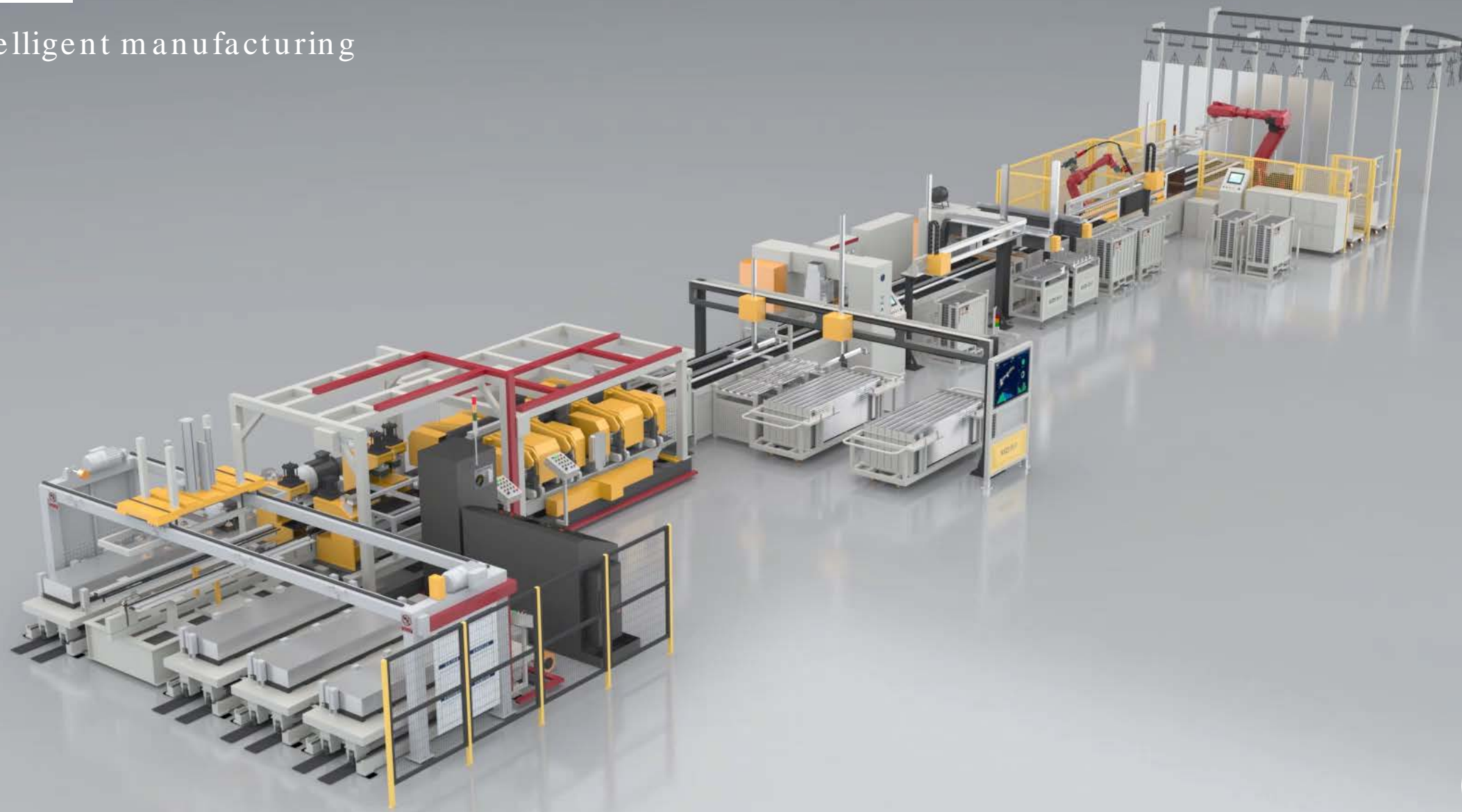

D

Marketing Network

---

Focus on China

XIZI 西子电梯



97

Branch offices

740

Stationing service organization

## Global marketing

- Overseas market has covered Europe, the Middle East, Southeast Asia, central Asia five countries, Africa, Latin America and other 70 countries and regions.
- Established exclusive agents and long-term strategic partners, and a systematic overseas sales and service system.



# E

## Engineering Guidance

---

# Smart QR code installation guide

40+

## Key processes guidance

- Solve the key and difficult points of on-site installation,
- Improve the efficiency of installation
- Improving the quality of installation on site. □
- Shorten the project installation cycle.



Speed governor fixed frame



Car rail bracket

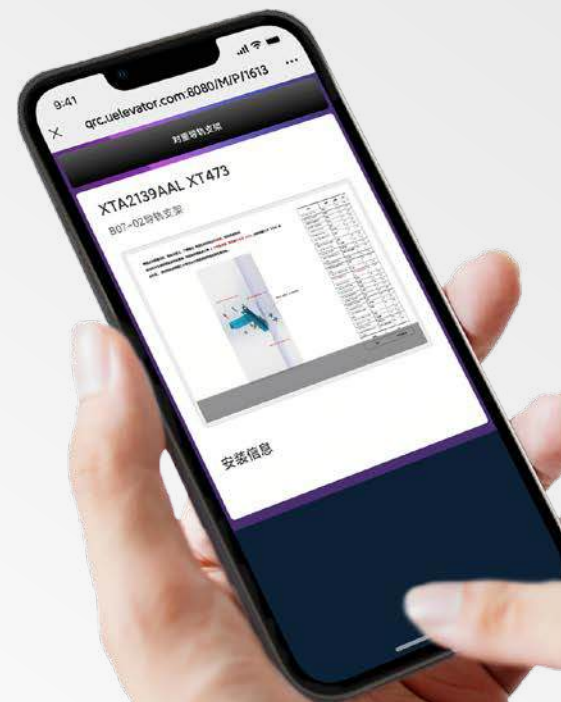

Gearless traction machines

## Overseas engineering team

## Overseas engineering team

Professional technical team, abundant overseas engineering experience, perfect after-sales service system,  
Efficient service to every customer, to ensure the safe operation of every elevator.

### Project Management

- Installation project management
- Maintenance Project Management



### Support Training

- Product technical training
- Commissioning and acceptance support
- Remote on-site support



### After Sales Service

- TB Processing Centre
- Parts Service Centre
- Retrofit Service Centre



F

Products Introduction

---



## Product Range - Vertical Lifts

**XIZI** 西子电梯



UN-Victor  
MR Passenger lift



GCS8000  
High-speed lift



i5 20  
Home lift



UN-Grace  
panoramic lift



UN-Victor mrl  
MRL Passenger lift



G3 Steel belt  
passenger lift



UN-Bed  
Hospital Elevator



UN-F5 000  
Cargo Lift

Product range - Horizontal passenger flow

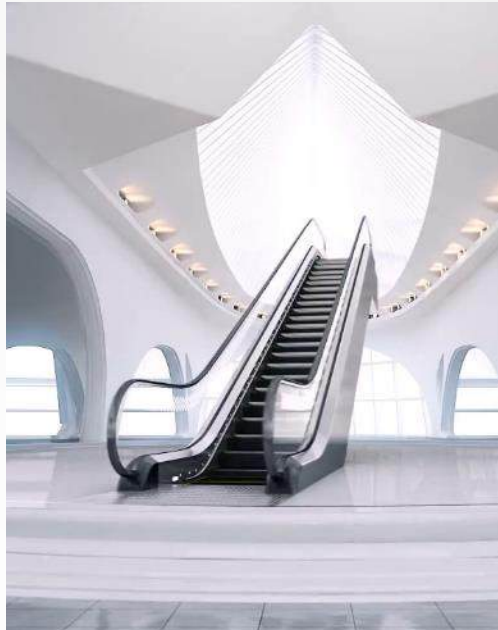

XEC-6000  
Integrated drive escalator



UN-ES008  
Commercial escalator

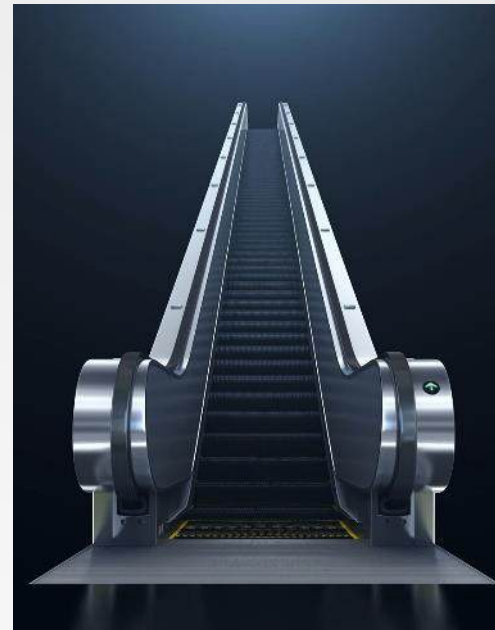

XEP  
Public transportation escalator

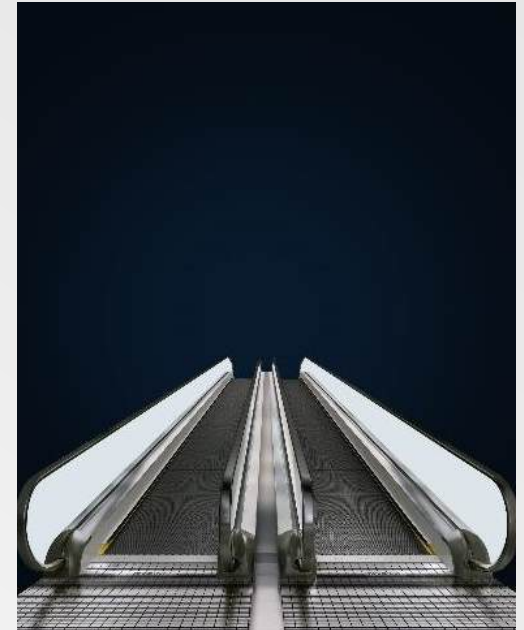

UN-ET008  
Moving walks

G

Classical Projects

---



## Strategic cooperation

One of Top Hundred Enterprises				
				
				
				
				
Commercial Chain Enterprise				
				

## Public Infrastructure

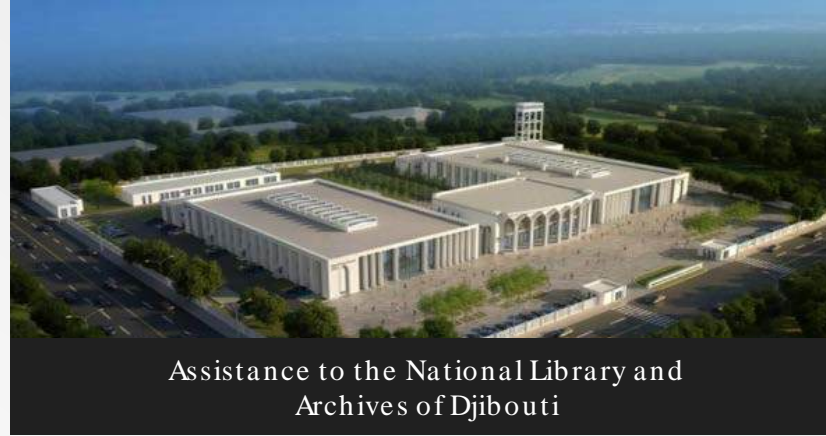

## Public Infrastructure

Huanglong Sports Centre  
Hangzhou

Assistance to the National  
Library and Archives of Djibouti  
Djibouti

International Convention and  
Exhibition Centre  
Qingdao

The Gate of Lin'an  
Hangzhou

BC Tetris Office Building  
Ukraine

## Rail traffic

**XIZI 西子电梯**

## Rail traffic

Metro Line 5 of Hangzhou  
Hangzhou

Train stations in Bolivian cities  
Bolivia

Seoul Subway  
Korea

Taoyuan MRT  
Taiwan, China

Tianjin Metro Line 10  
Tianjin

Chongqing Baiheliang  
Underwater Museum  
Chongqing



Metro Line 5 of Hangzhou



Train stations in Bolivian cities



Seoul Subway



Taoyuan MRT



Tianjin Metro Line 10



Chongqing Baiheliang  
Underwater Museum

## Airport Projects



## Airport Projects

Los Cabos Airport T3  
Mexico

HATYAI airport  
Thailand

Chiang Rai International Airport  
Thailand

Puerto Vallarta Airport  
Mexico

## Star hotels



## Star hotels

Shanghai Marriott Hotel  
Shanghai

Wyndham Grand Hotel,  
Golden Mission Bay Tower  
Duyun

Boshier International Hotel  
Zhengan

The Pleasant House  
Radisson five-star hotel  
palau

Mercure Hotels  
Bali Island, Indonesia

## Commercial complexes



## Commercial complexes

D-Pristine Commercial Complex  
Malaysia

MEGAMOLL MALL  
Ukraine

Guizhou Zunyi OUTLETS  
Guizhou

Peninsula Tijuana Shopping mall  
Mexico

KOOHSANGI SHOPPING MALL  
Iran

## Hospital Projects



## Hospital Projects

Hangzhou Lin'an TCM Hospital  
Hangzhou

Qufu City People's Hospital  
Qufu

Kitwe Central Hospital  
Zambia

Essalud Lima Hospital  
Peru

Chengdu CCMU Yin Hai Eye Hospital  
Chengdu

# International Universities



## International Universities

Zhejiang Gongshang University  
Hangzhou

Shandong Provincial Hospital University  
Jinan

Shanghai Jiaotong University  
Shanghai

San Marcos College  
Peru

Wuhan Engineering University  
Wuhan

## Residential Projects



## Residential Projects

Guangxi Taihehua Mansion  
Guangxi

Wang Kui Louju, Jinan Jiyang  
Shandong

Строительная компания АВИЦЕНА  
Tajikistan

kanghu waterside  
Ningxia

## Residential Projects

XIZI 西子电梯

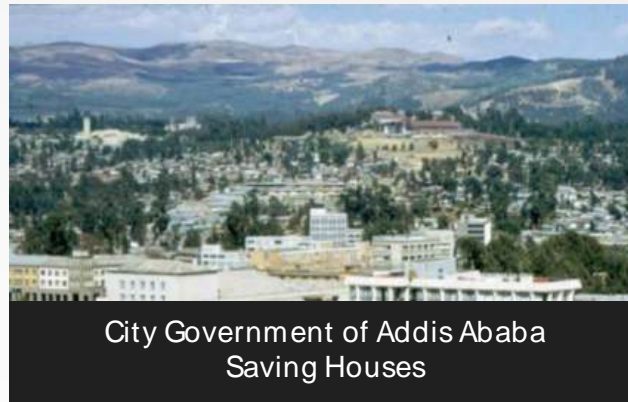

## Residential Projects

Hebei Shengshi Public House  
Hebei

ВИП СТРОЙ  
Tajikistan

Yurun City, Peixian, Jiangsu  
Jiangsu

City Government of Addis Ababa  
Saving Houses  
Ethiopia

## Residential Projects



Zhongtai Road Site



AIN BENIANE 1800



Four Seasons Ideal City



Zhongtong Royal View

## Residential Projects

Zhongtai Road Site

Jiangsu

AIN BENIANE 1800

Algeria

Four Seasons Ideal City

Henan

Zhongtong Royal View

Beijing

We are committed to being your **most reliable partner**

XIZI ELEVATOR CO. LTD

---

☎ 400-826-1112

📍 No. 2329 Science and Technology Ave., Lin'an Economic Development Zone, Hangzhou, China 311305

★ <https://www.xizielevator.com/>